

Little Anne

User Guide

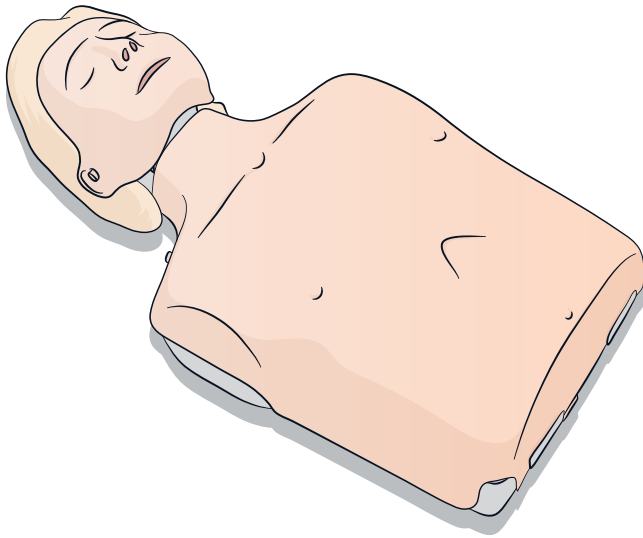

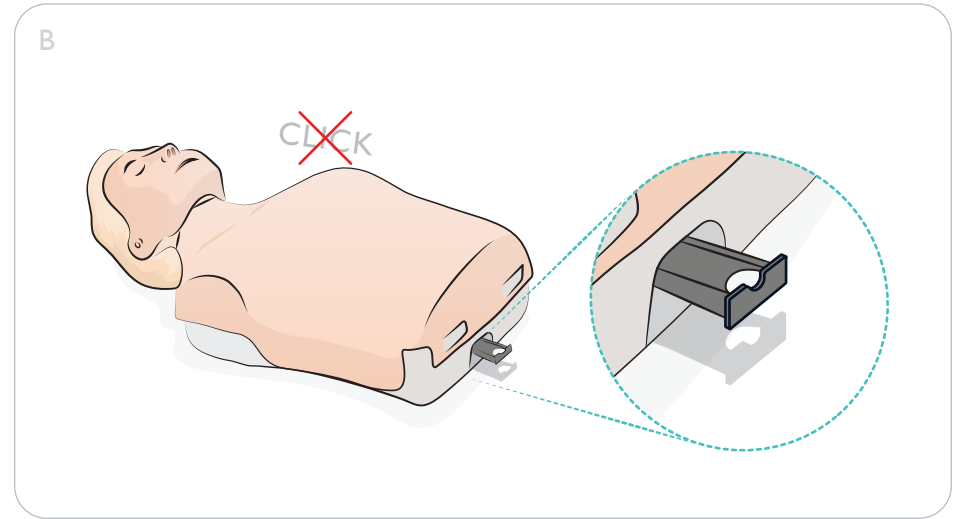

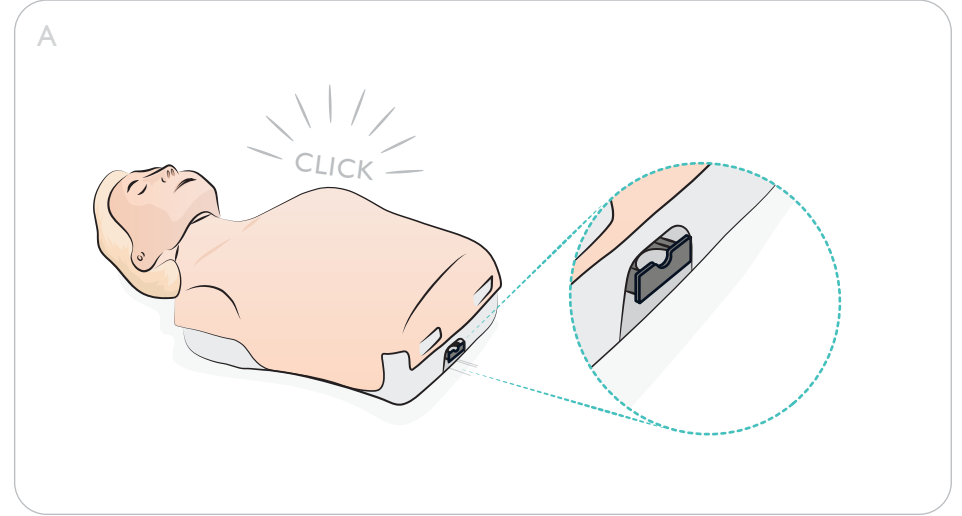
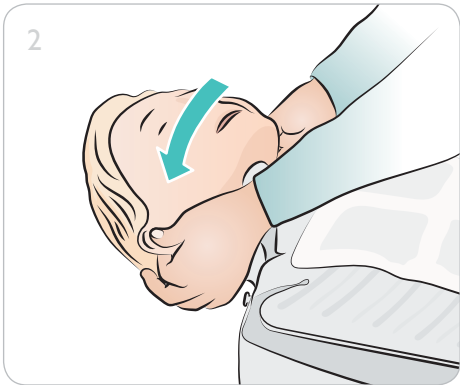
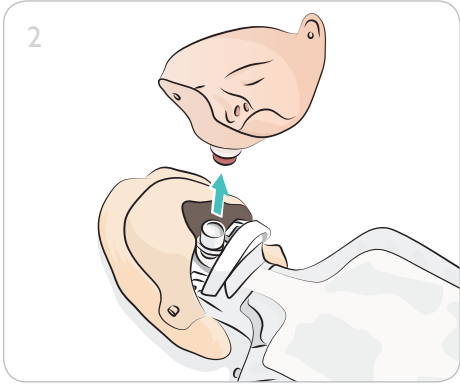
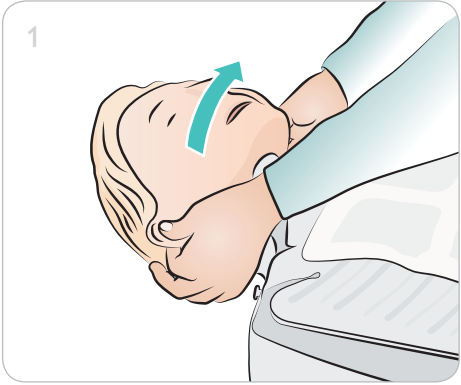
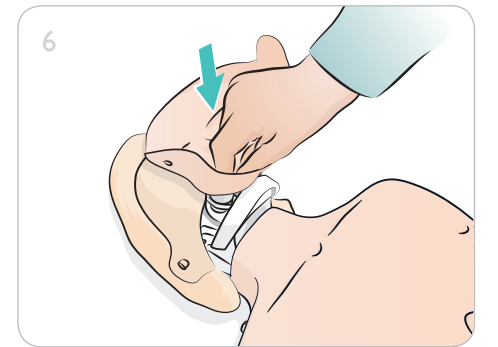
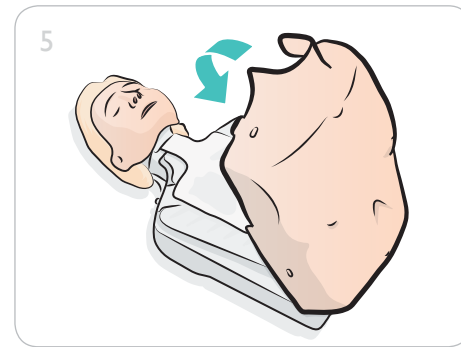
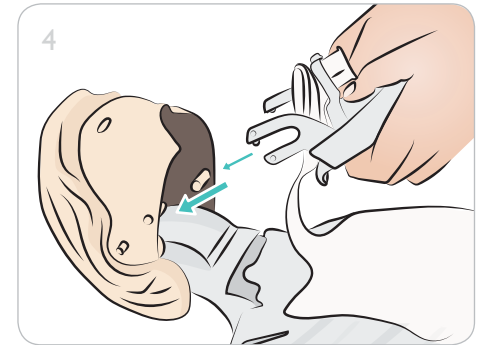
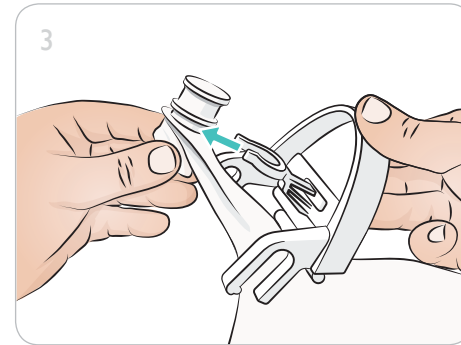
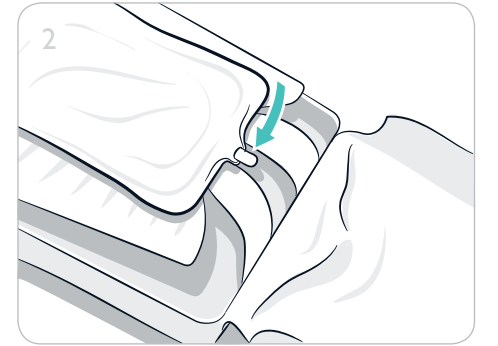
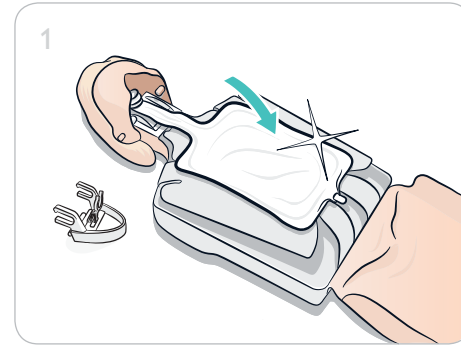
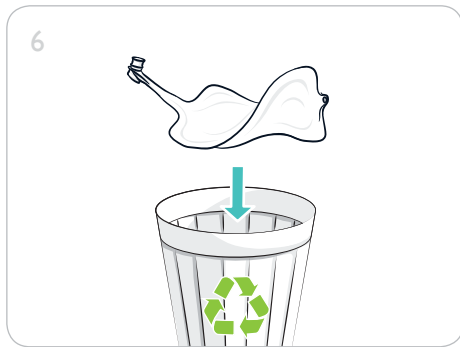
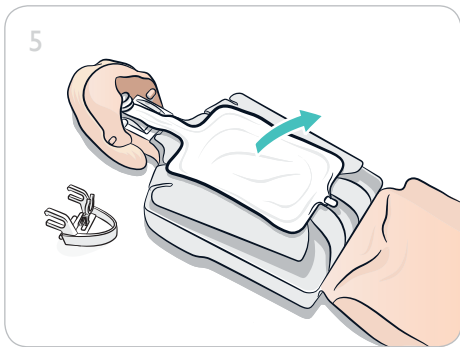
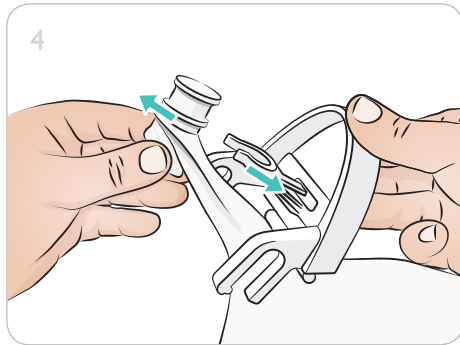
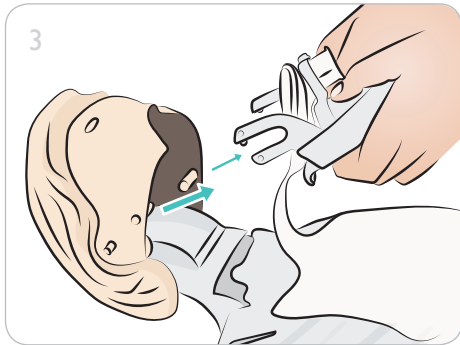
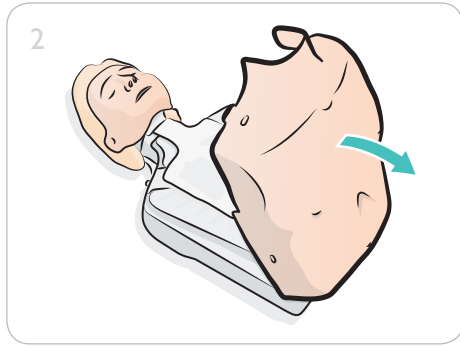
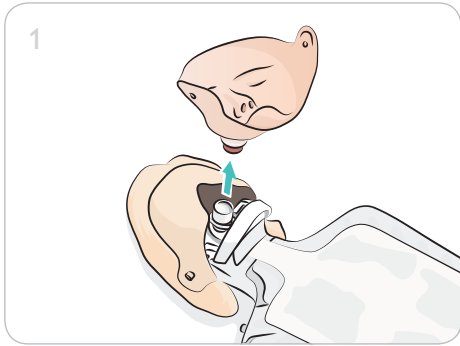

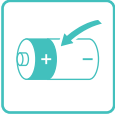

Little Anne QCPR

Little Anne QCPR

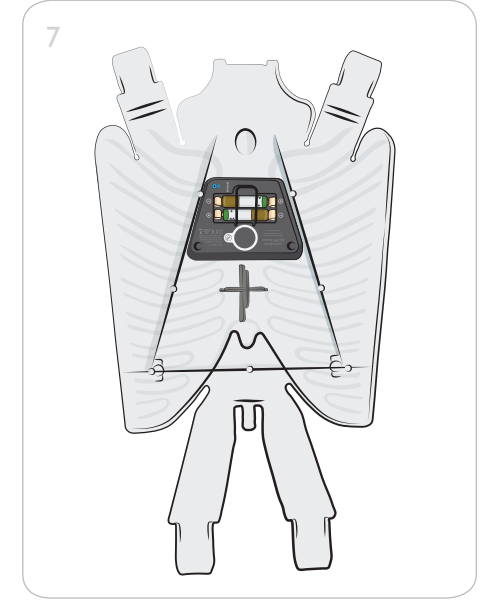
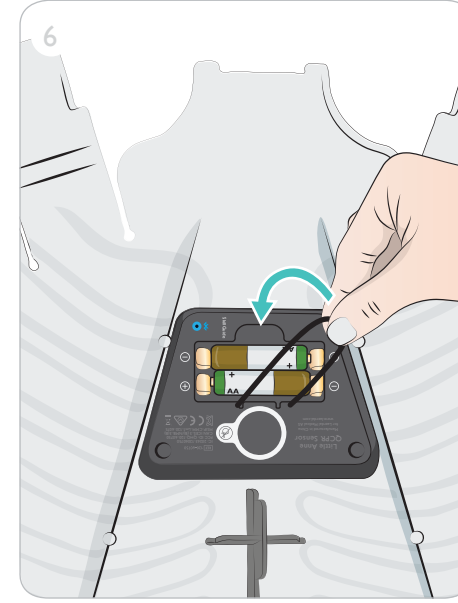
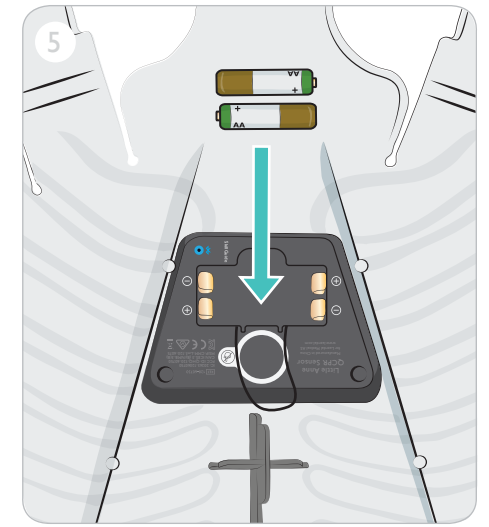
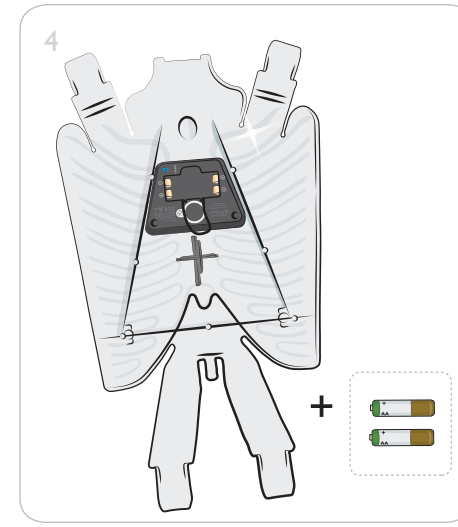
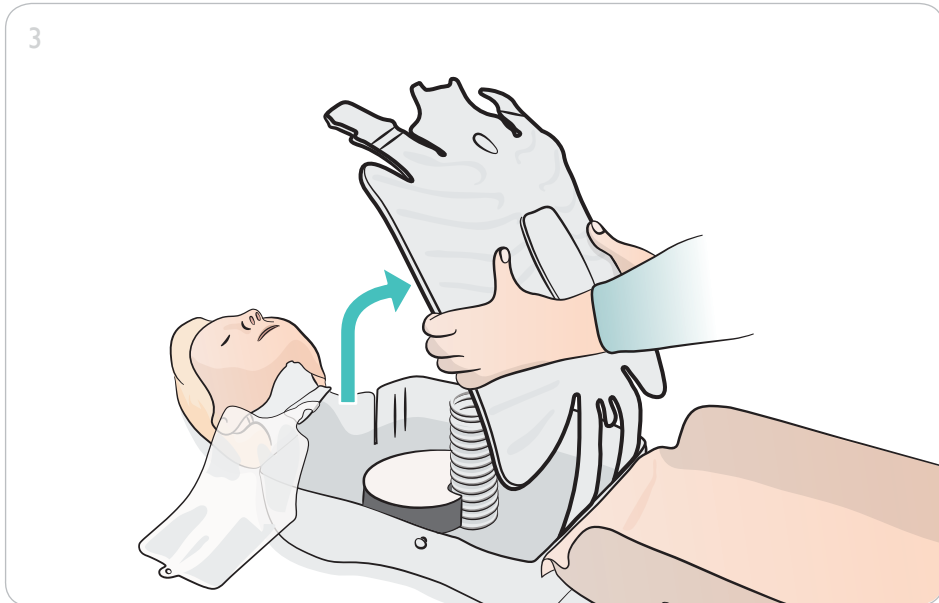
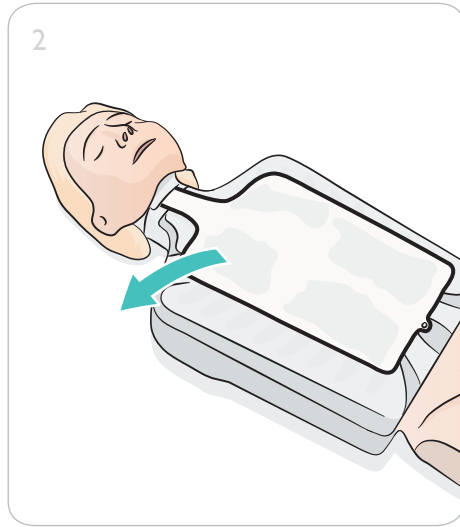
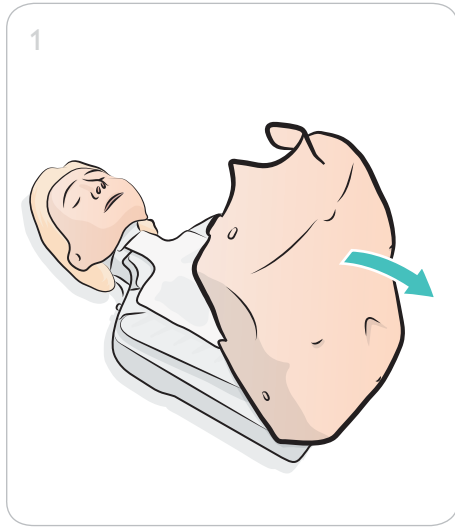

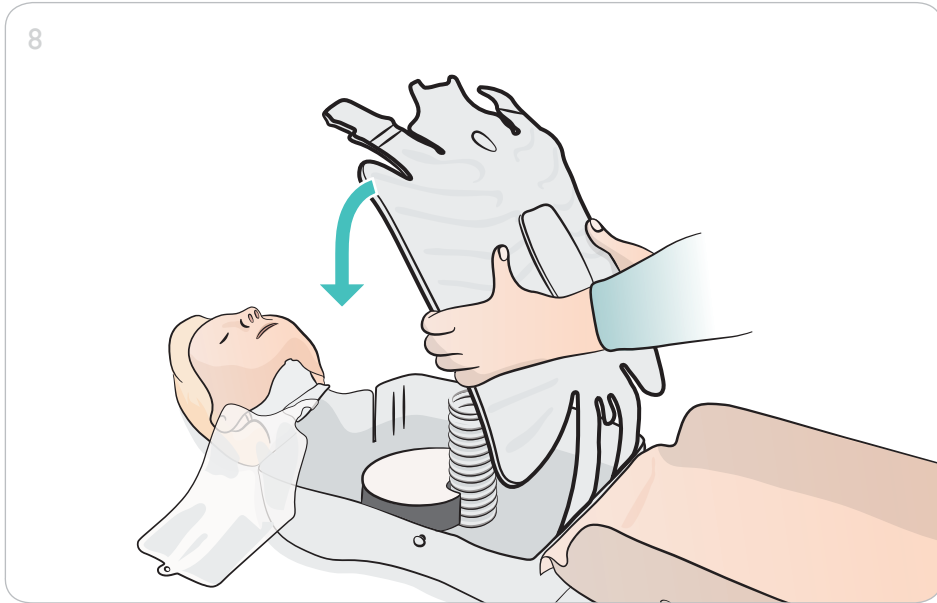

 Little Anne QCPR Instructor
Little Anne QCPR Learner

 Little Anne QCPR Learner

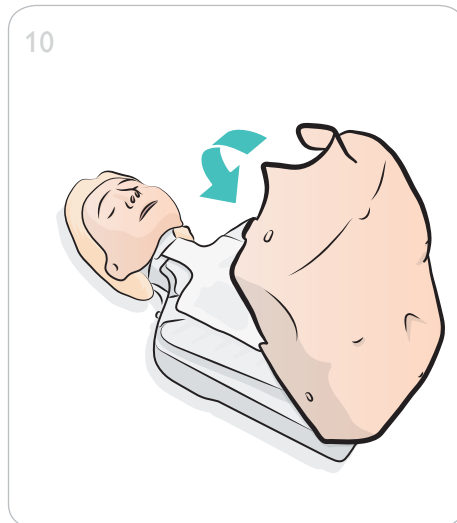
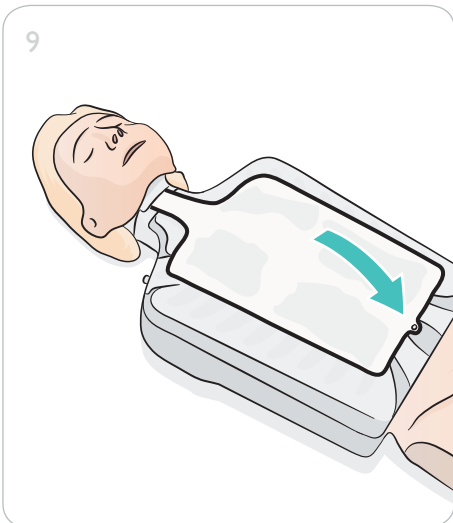

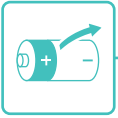

Little Anne AED

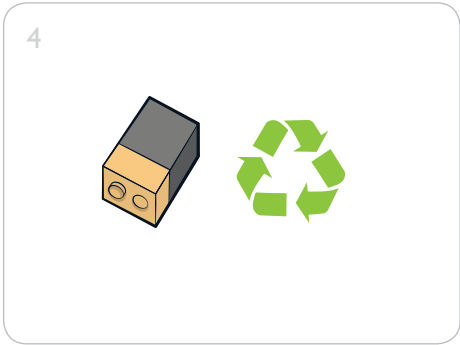
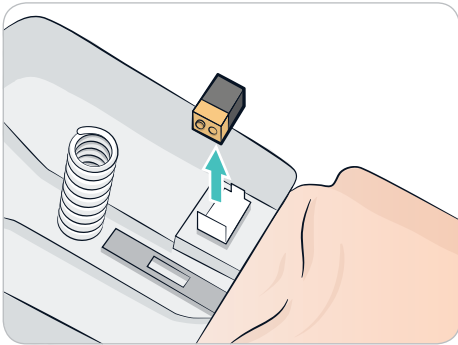
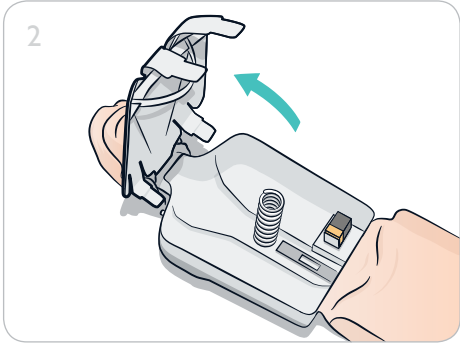
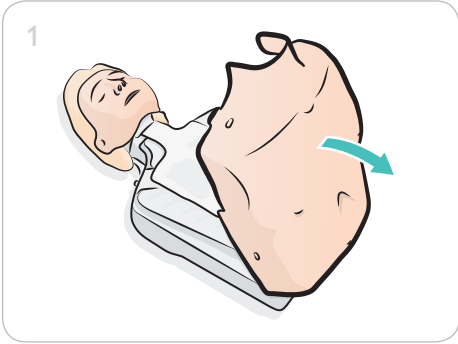

Little Anne AED

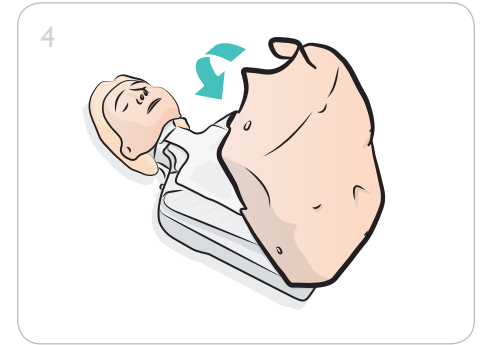
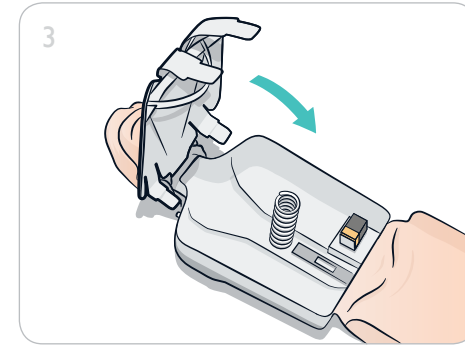
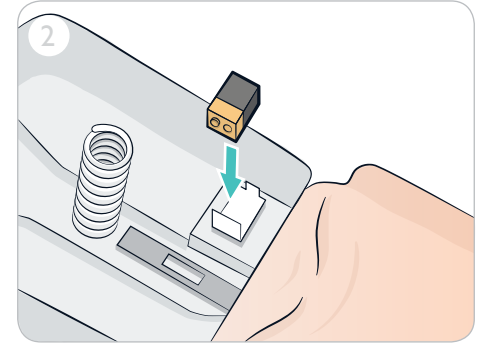
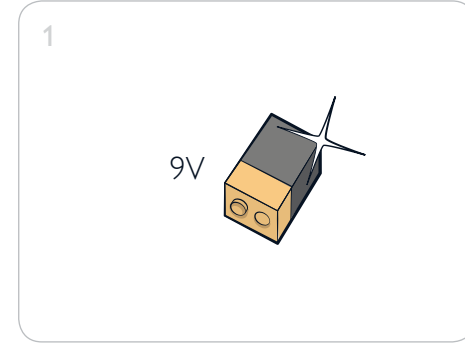
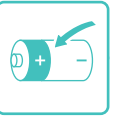

© 2017 Laerdal Medical AS. All rights reserved.
Device Manufacturer: Laerdal Medical AS, P.O. Box 377,
Tanke Svilandsgate 30, 4002 Stavanger, Norway
T: (+47) 5151 1700

20-11797 Rev A

www.laerdal.com



Laerdal
helping save lives